

FAST FOOD X FAST CHARGE

A SONIC/CHARGE POINT REDESIGN

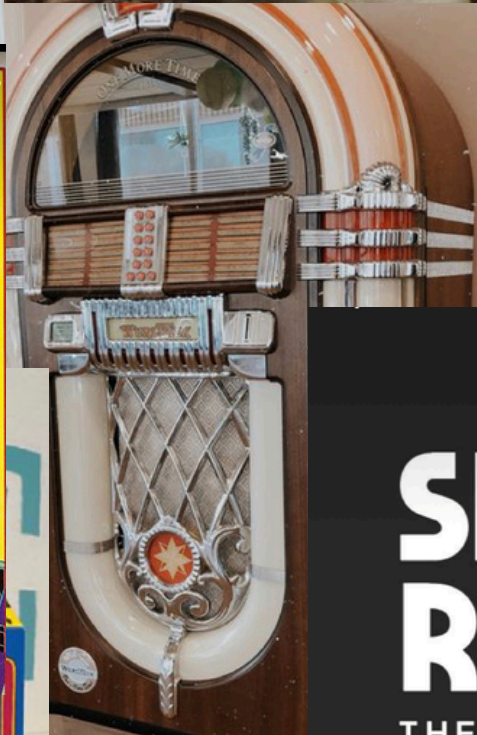

ITERATION ONE

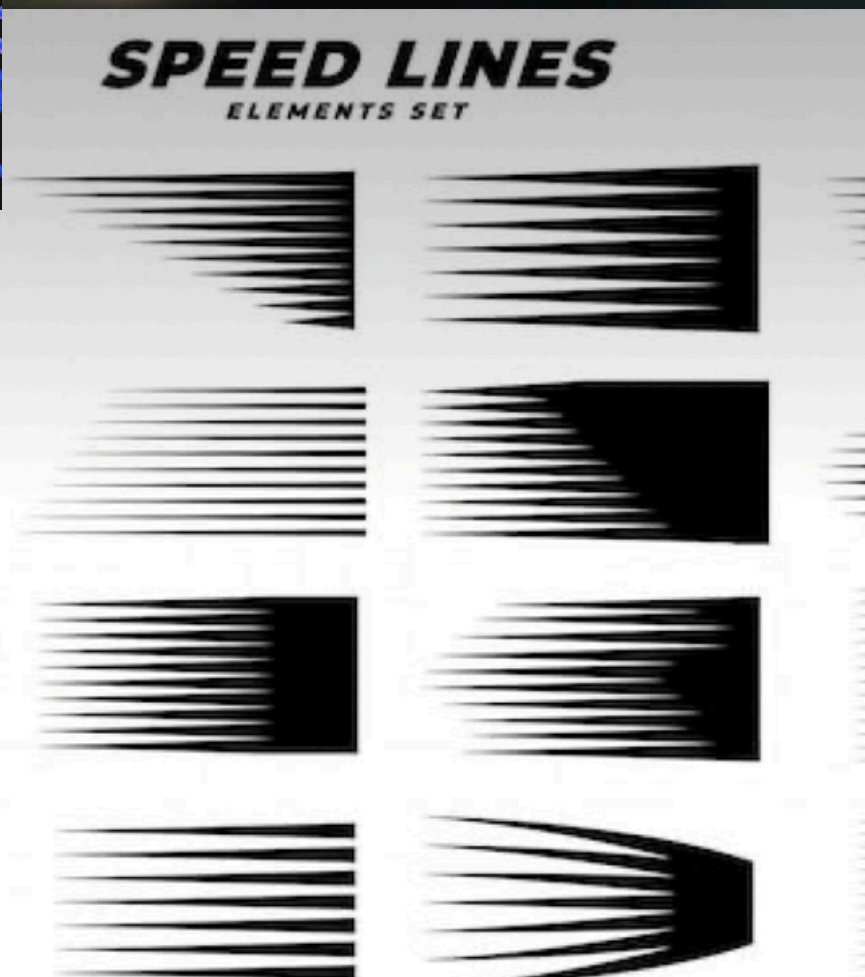
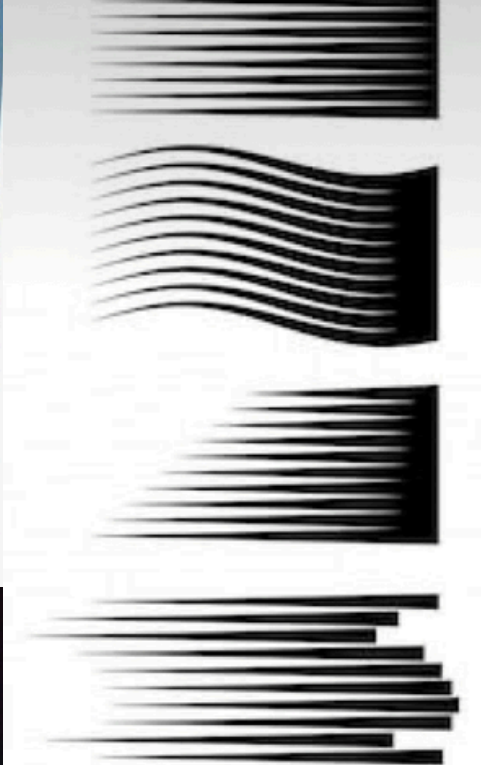
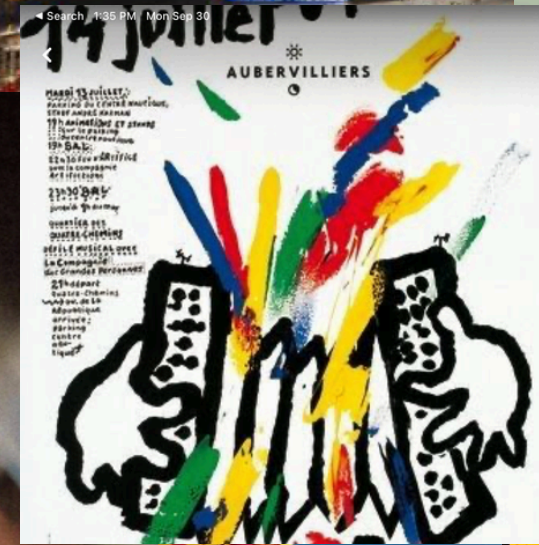
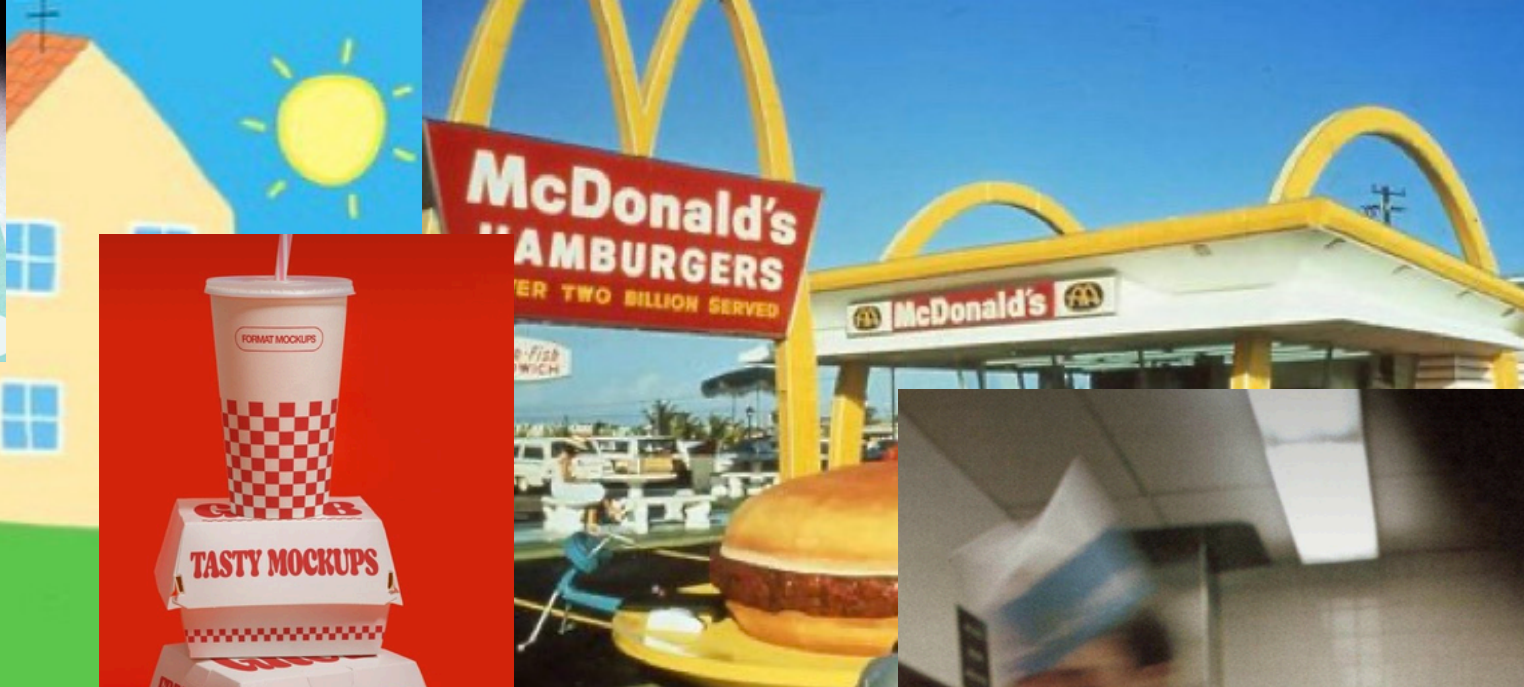

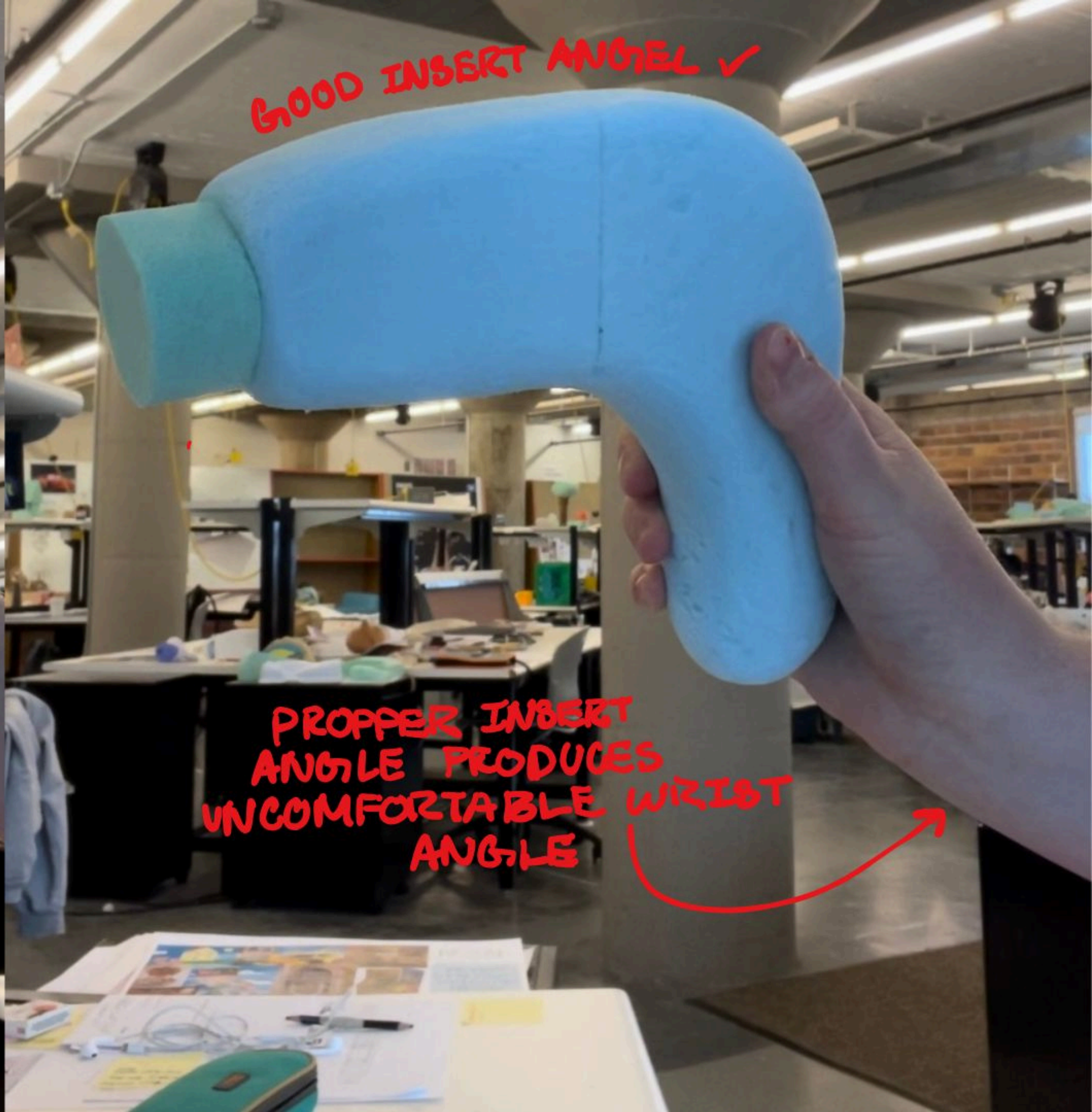

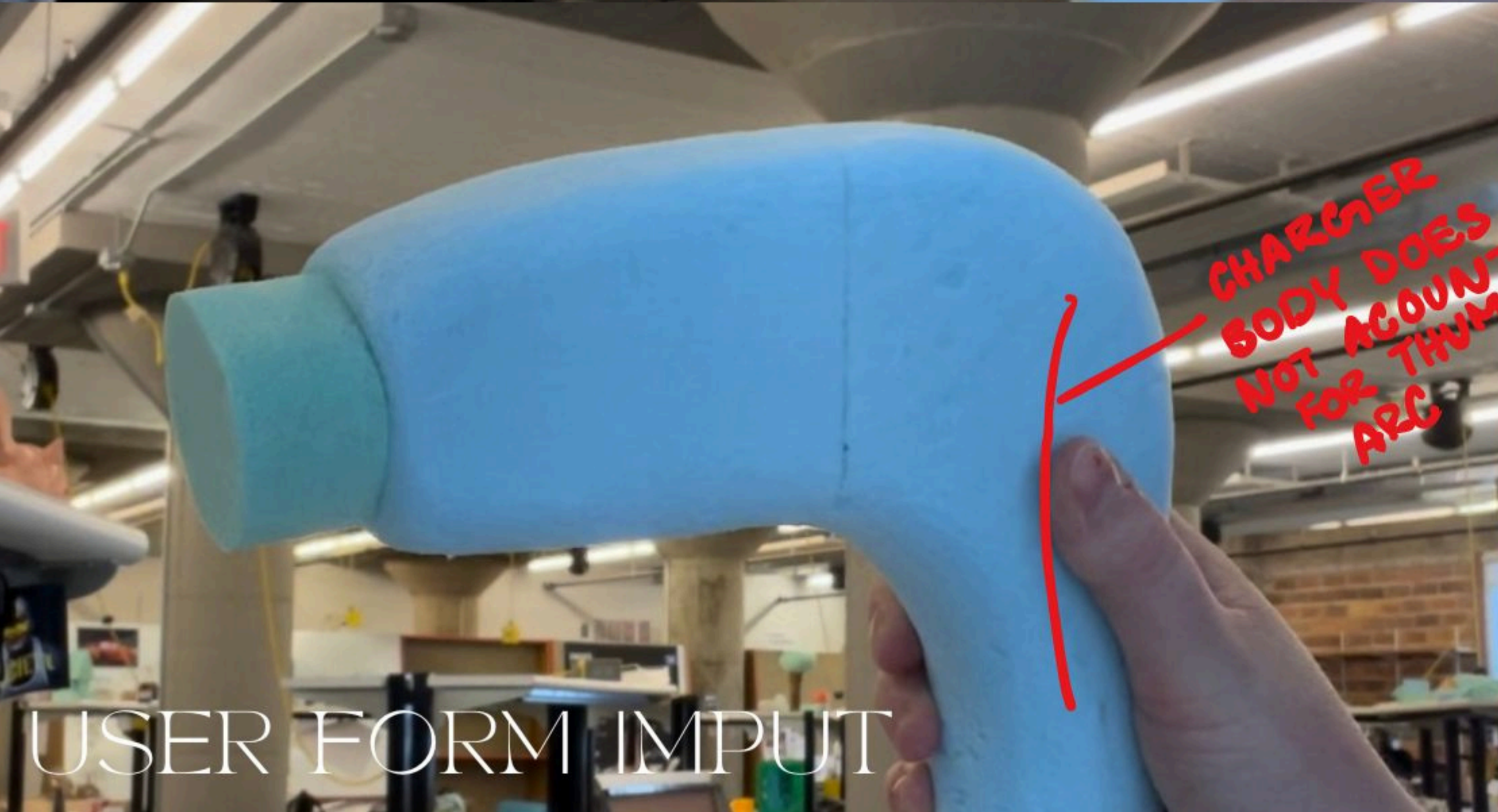
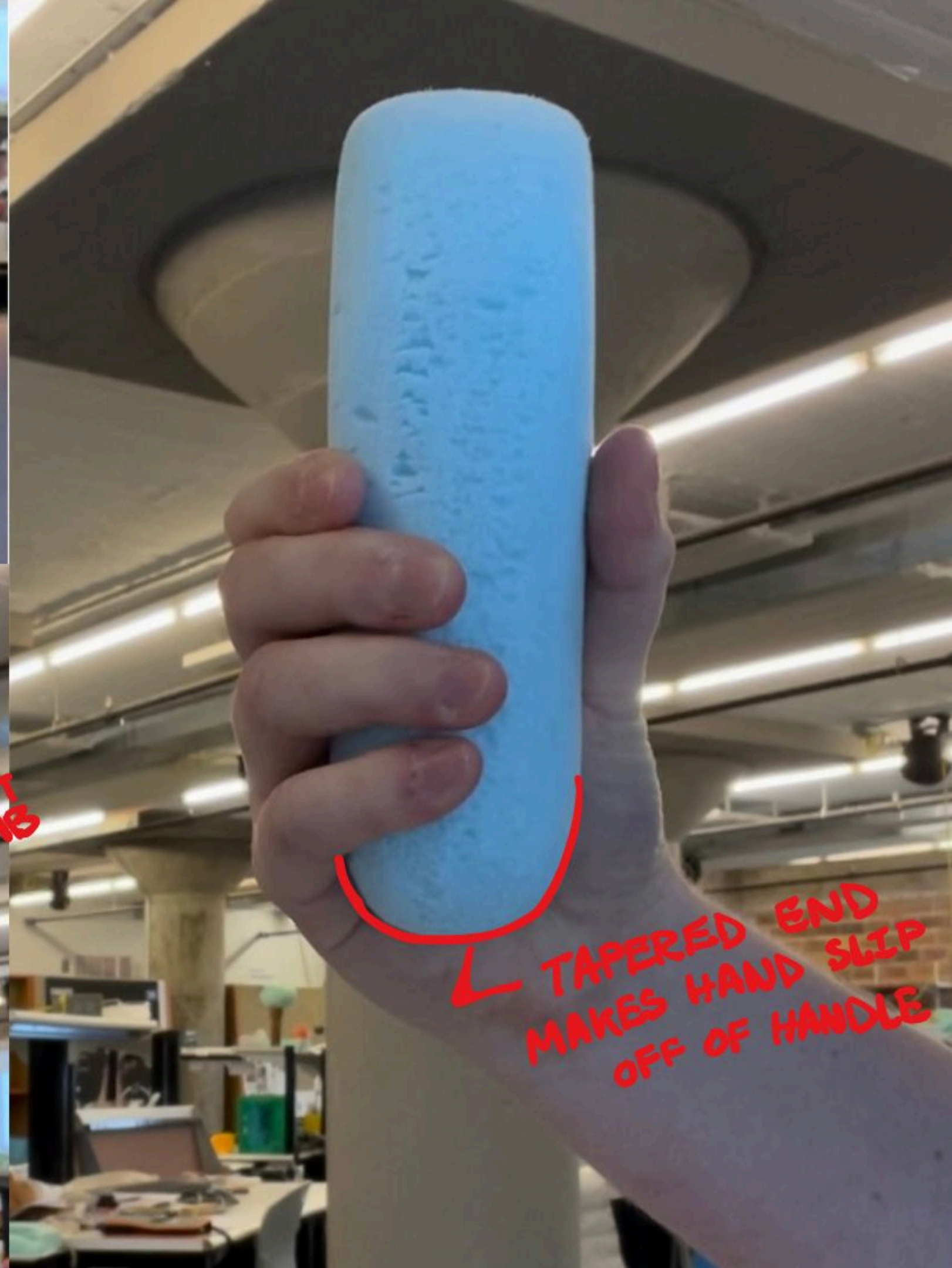
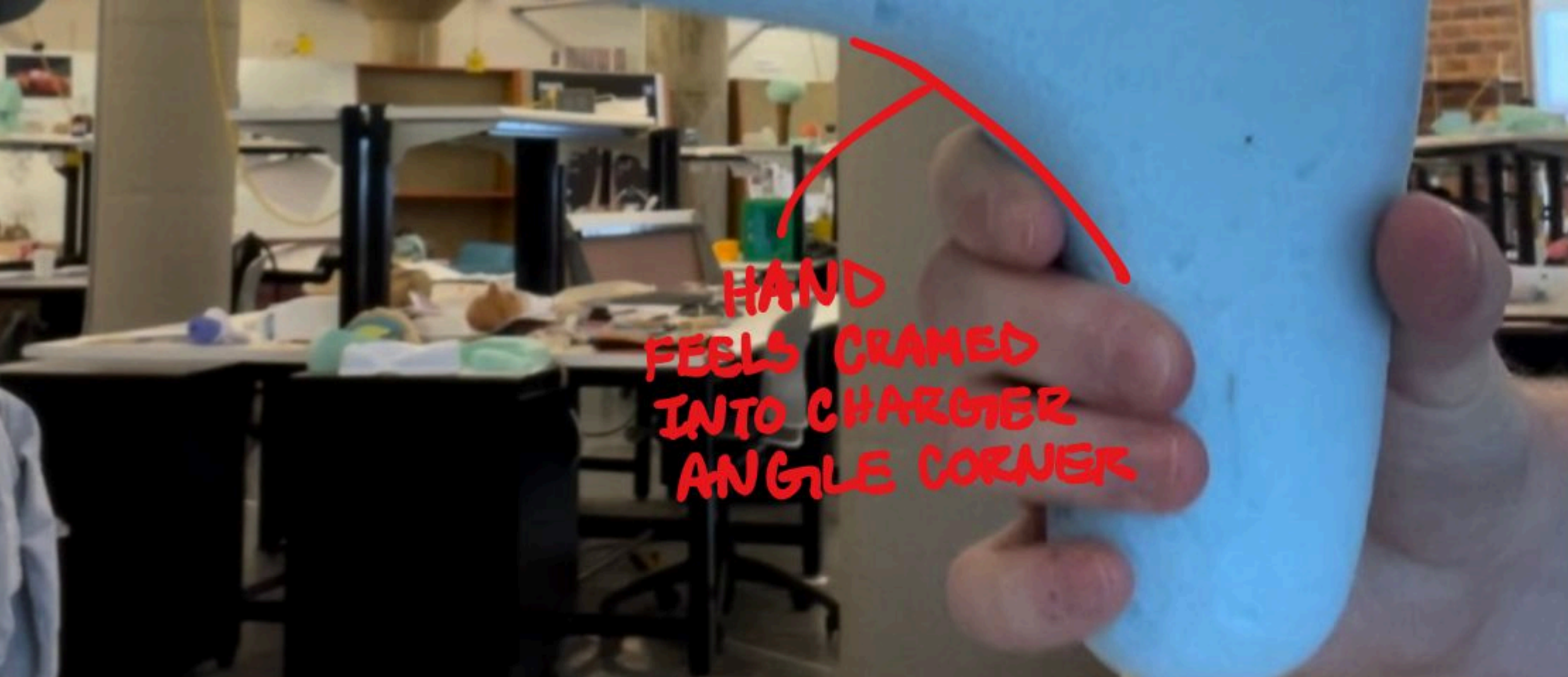

USER FORM INPUT

ITERATION TWO



TOP HEAVY MAKING
EV CHARGER HARD TO HOLD



USER FORM INPUT

SCALE IS
TOO BIG
MAKES USER
INTIMIDATED



USER FORM INPUT

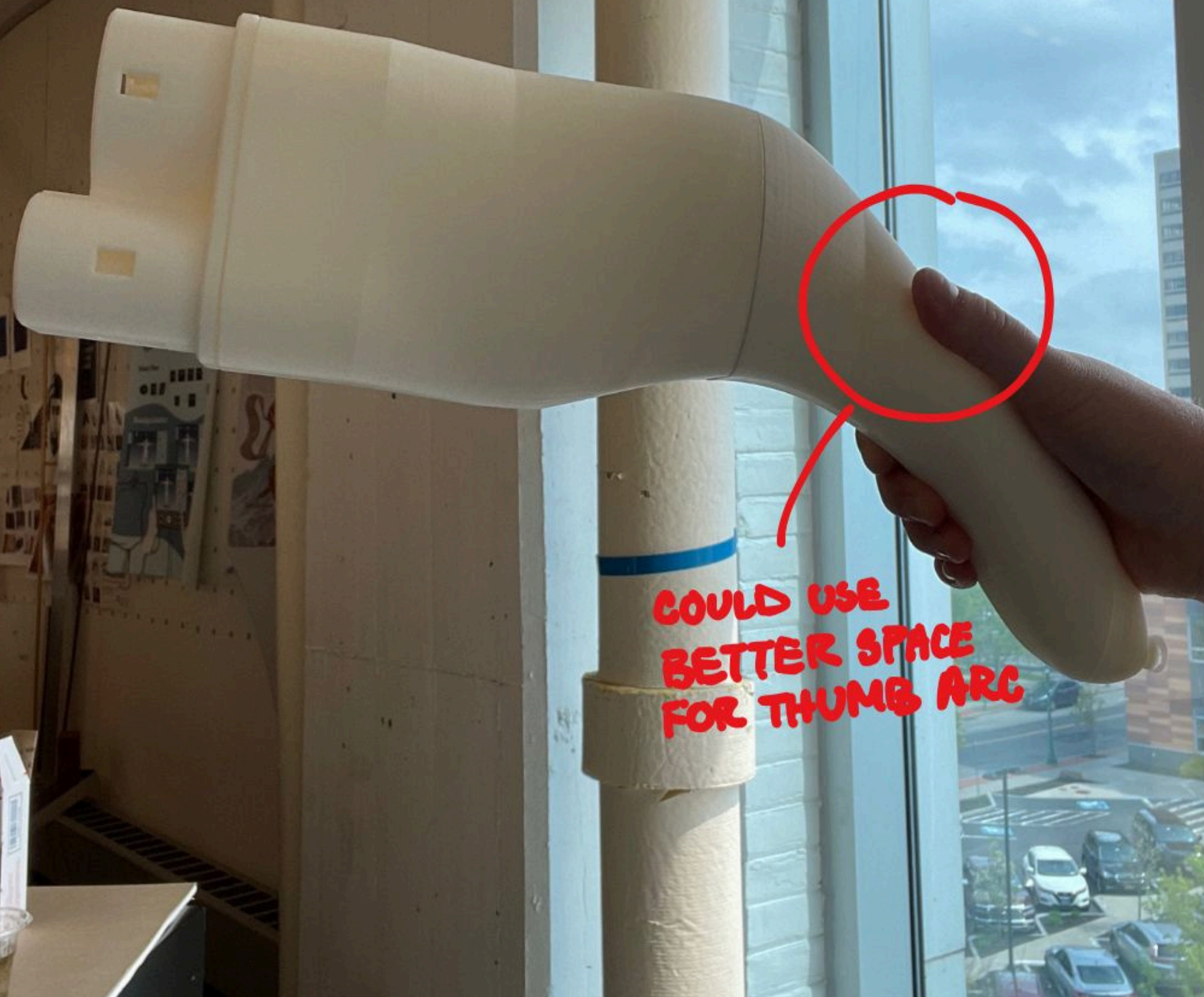

COULD USE
BETTER SPACE
FOR THUMB ARC

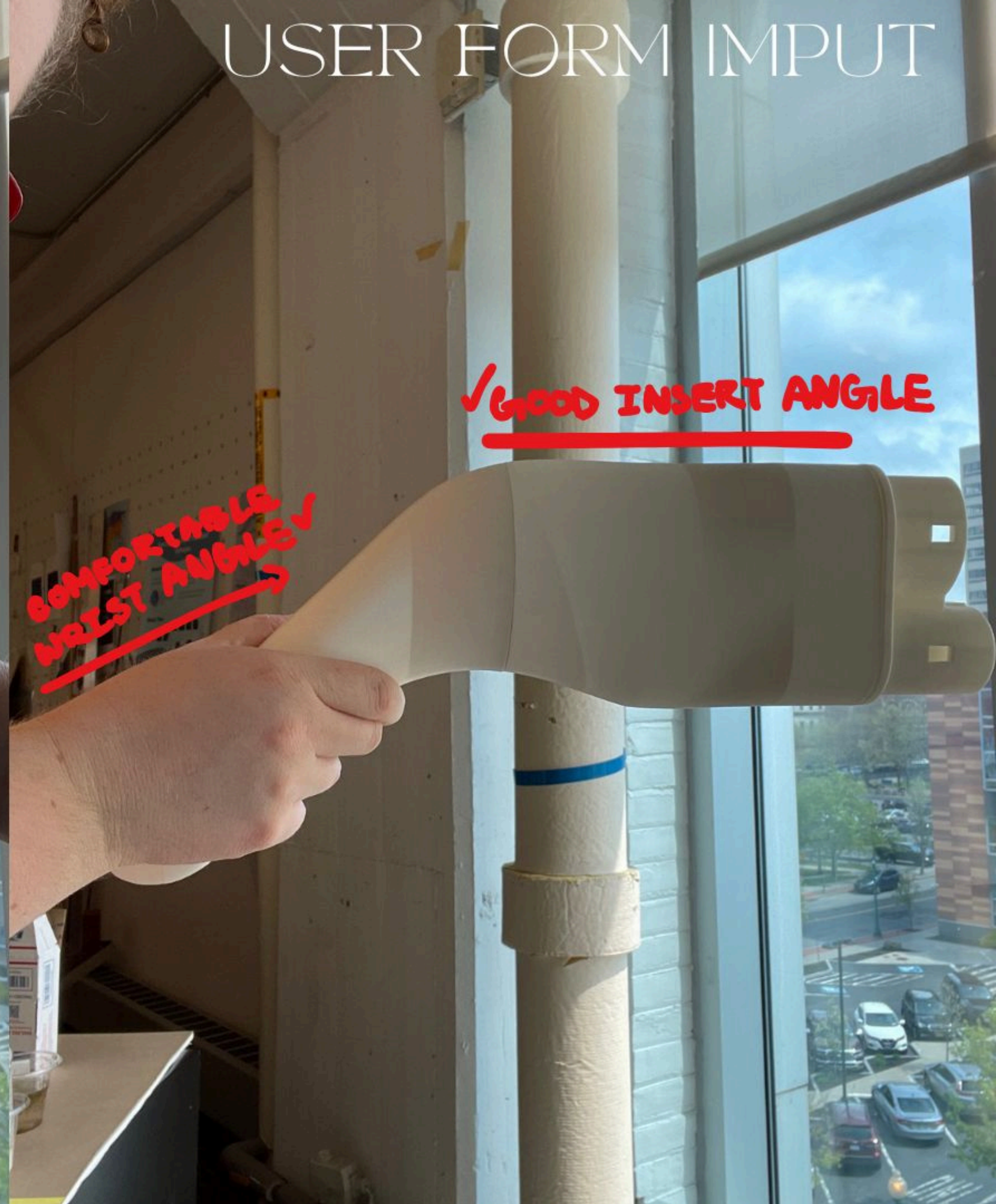

✓ GOOD INSERT ANGLE

✓ COMFORTABLE
WRIST ANGLE ✓

ITERATION THREE

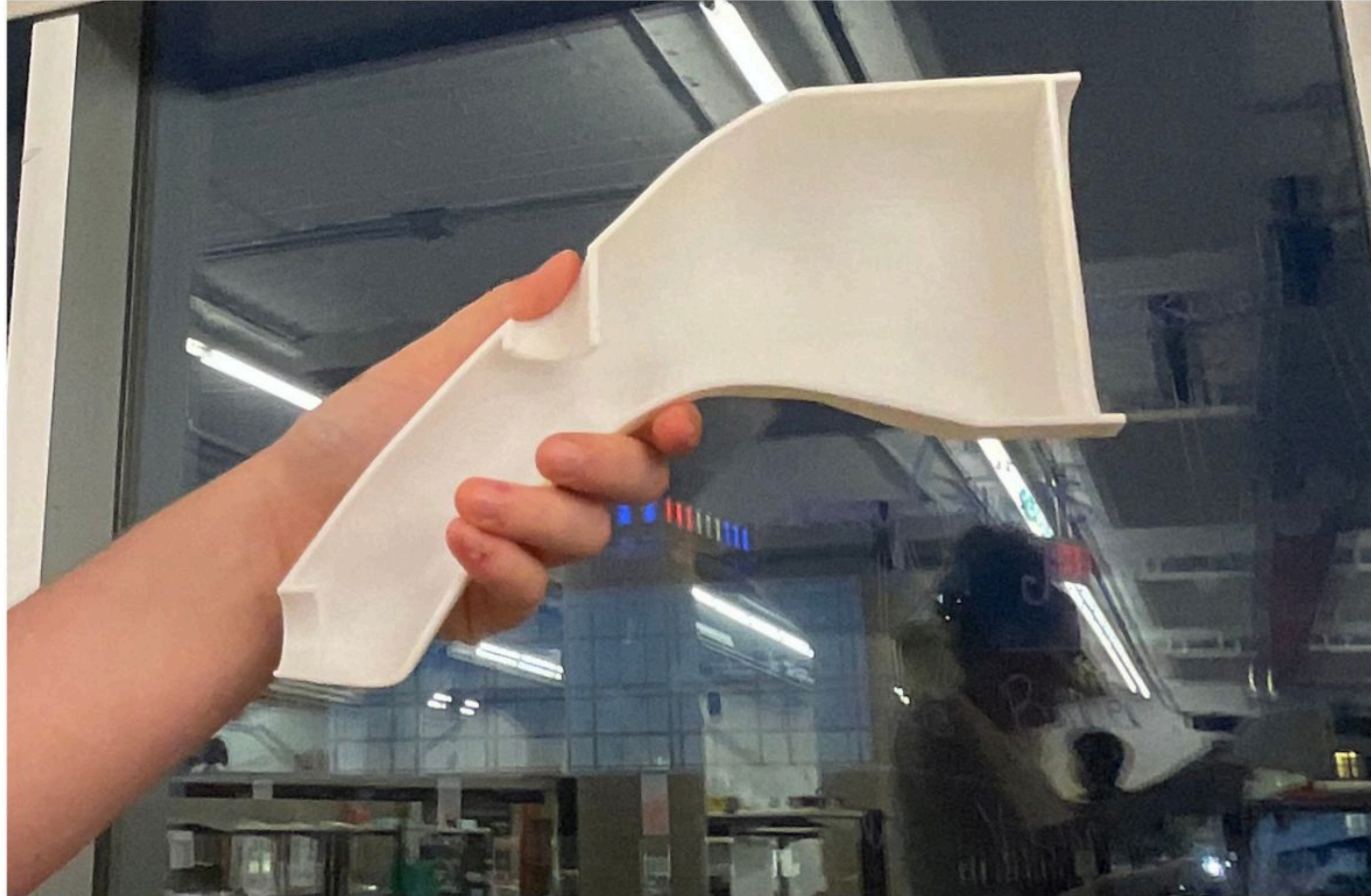

SOLIDWORKS PARTS

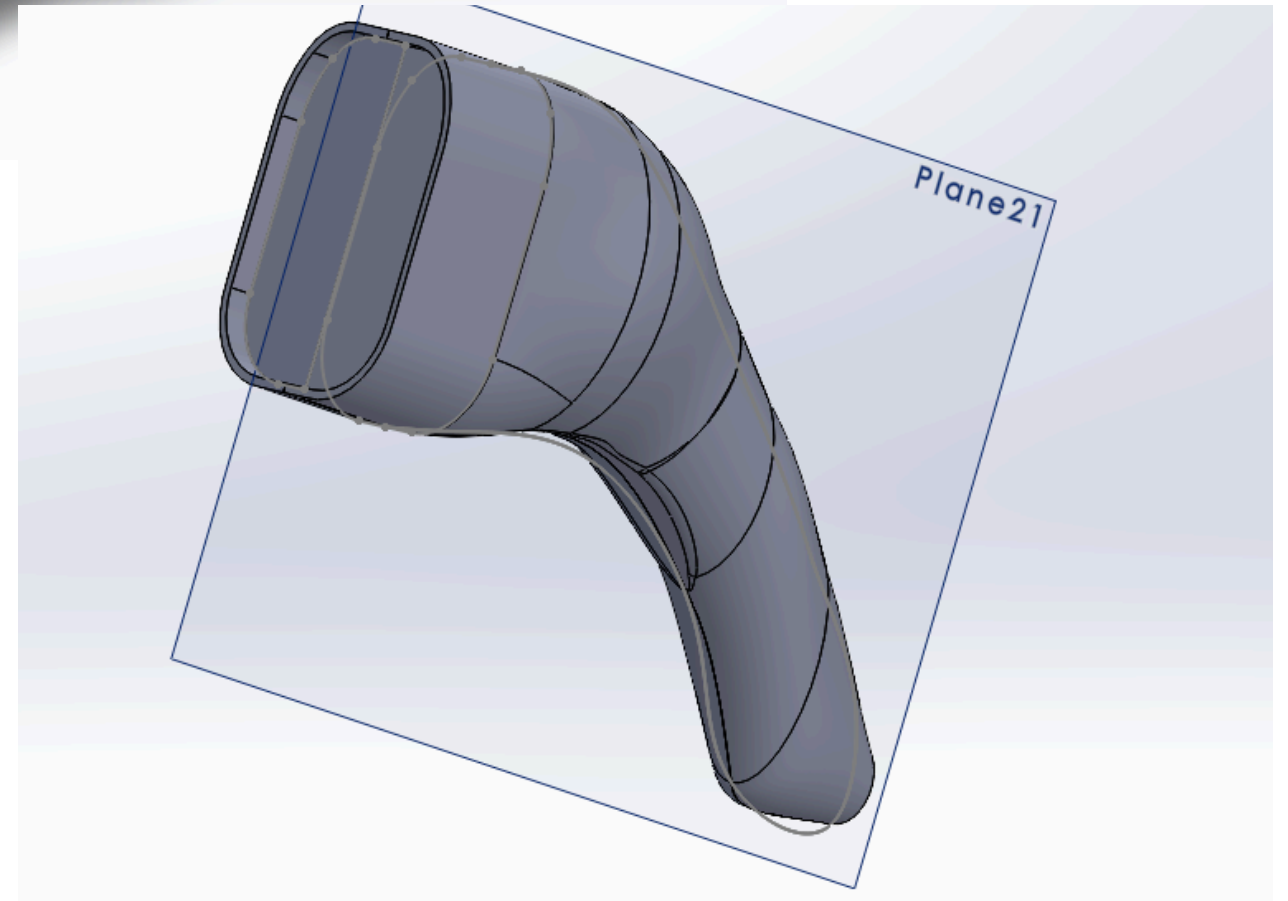
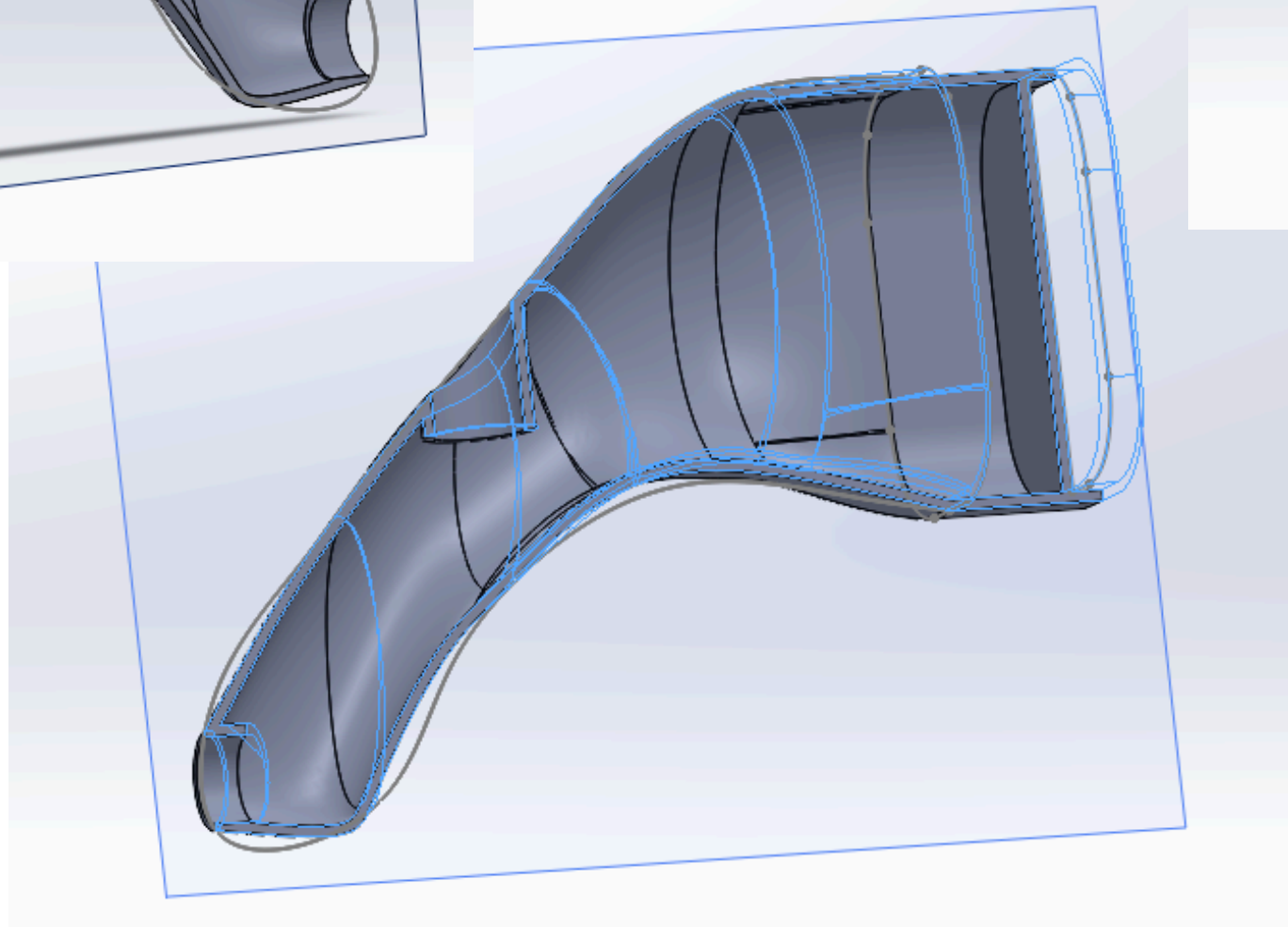
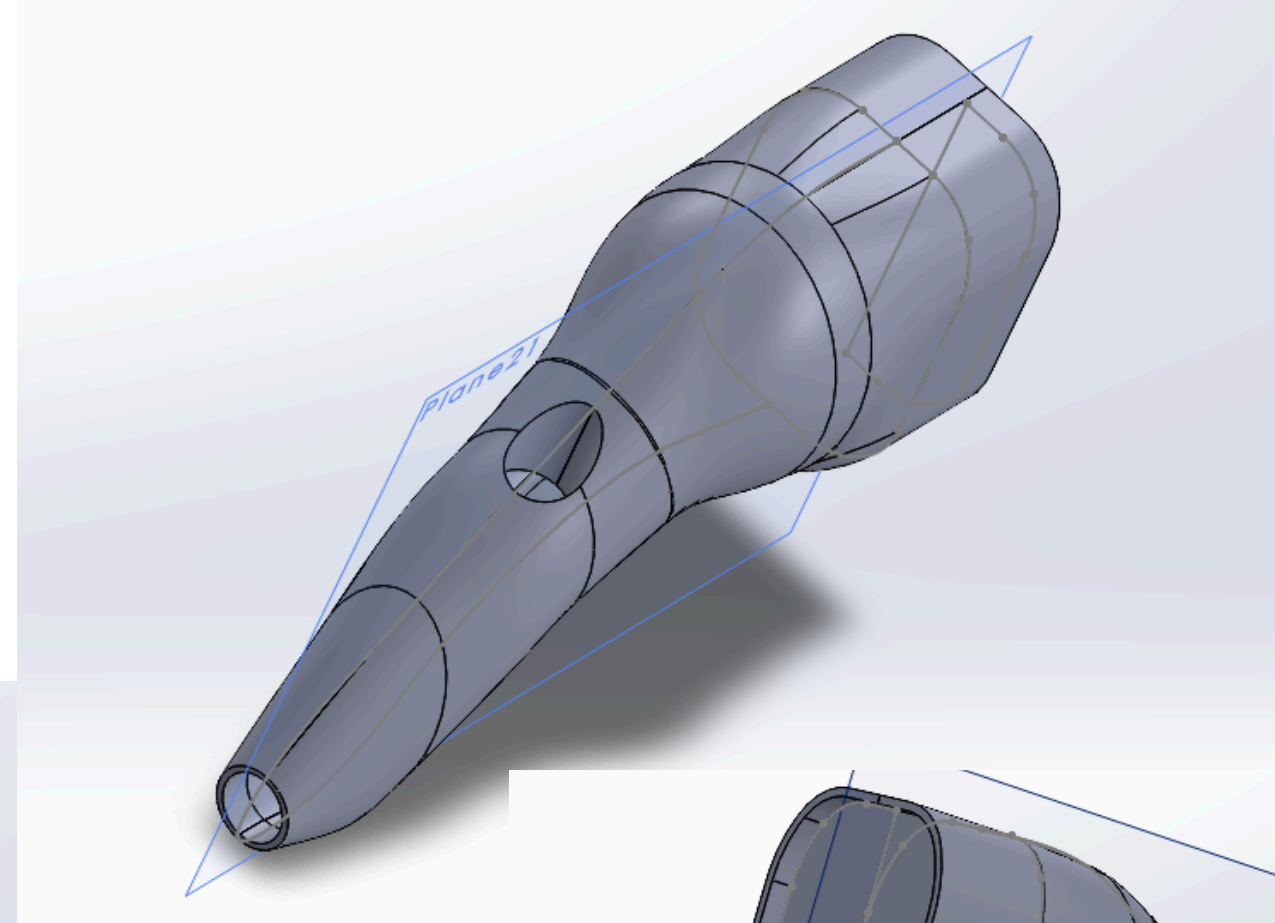
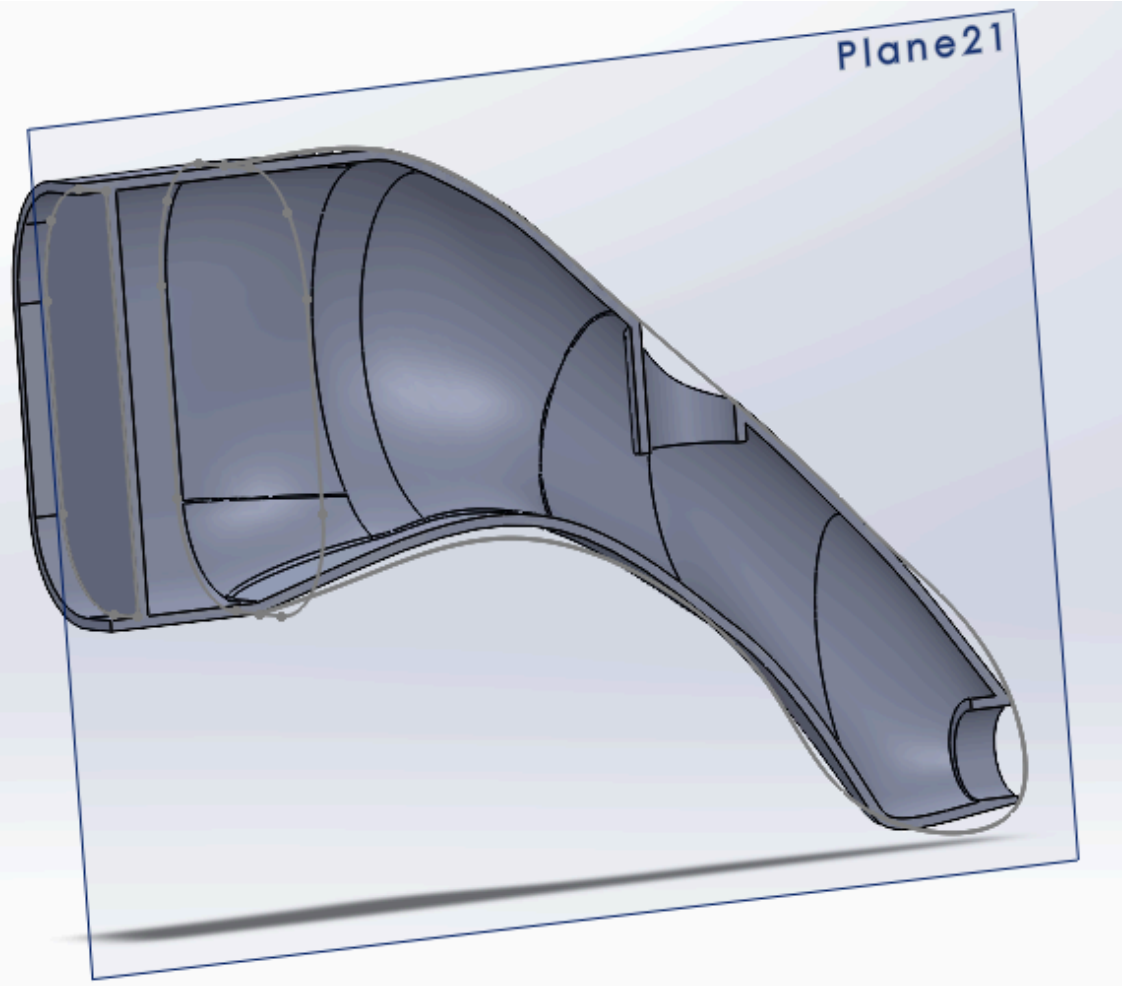

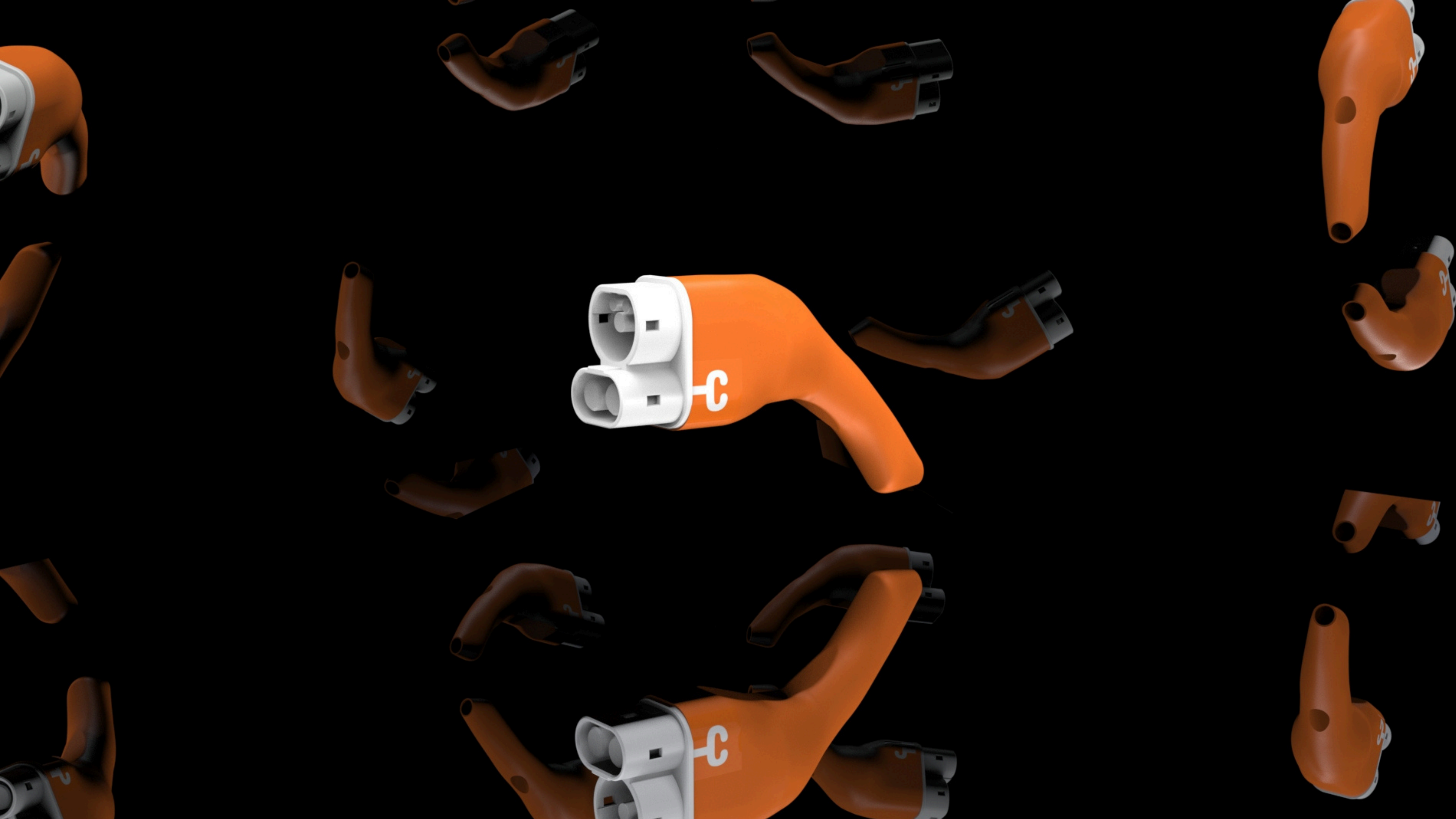

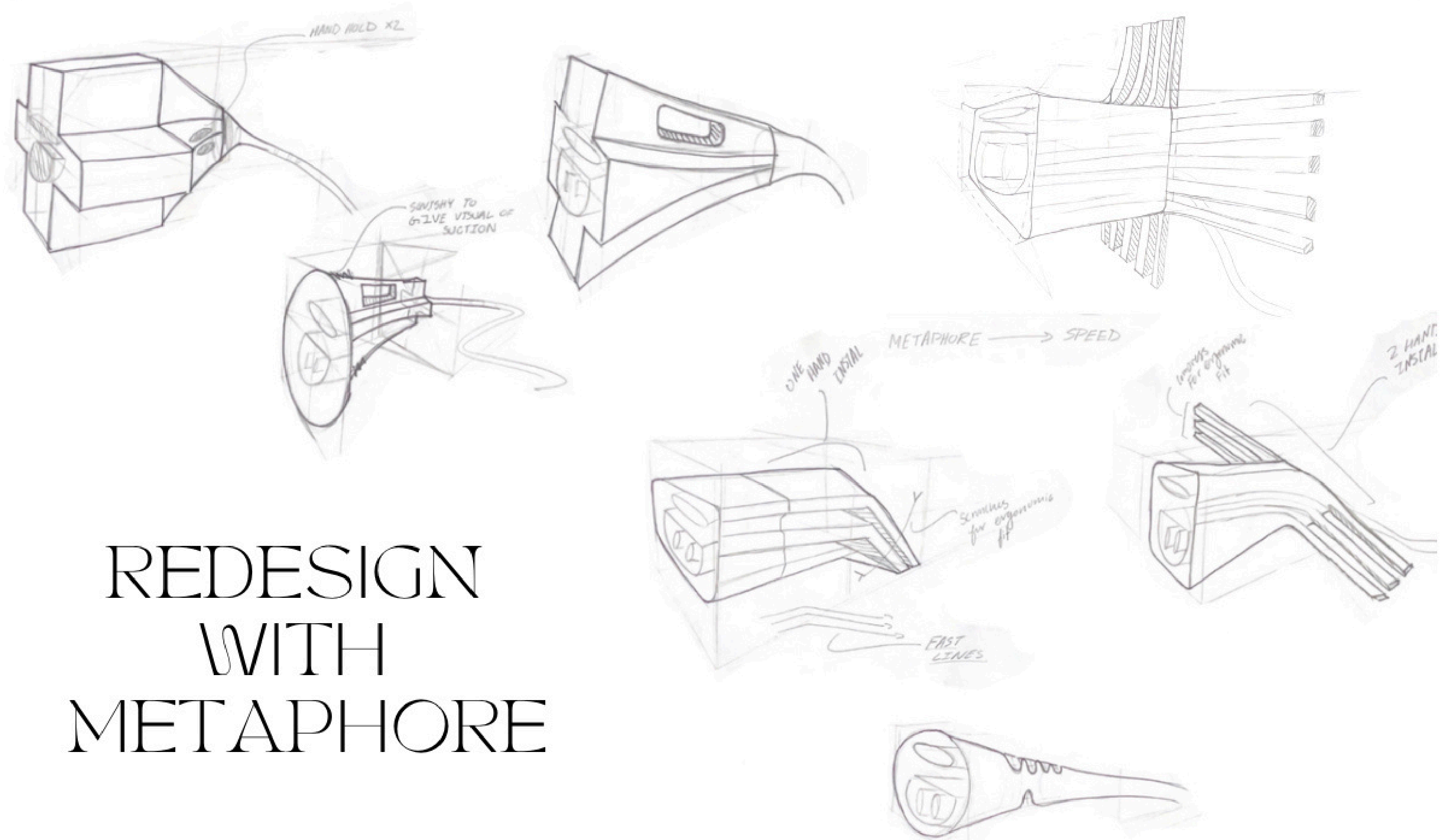

REDESIGN WITH METAPHORE

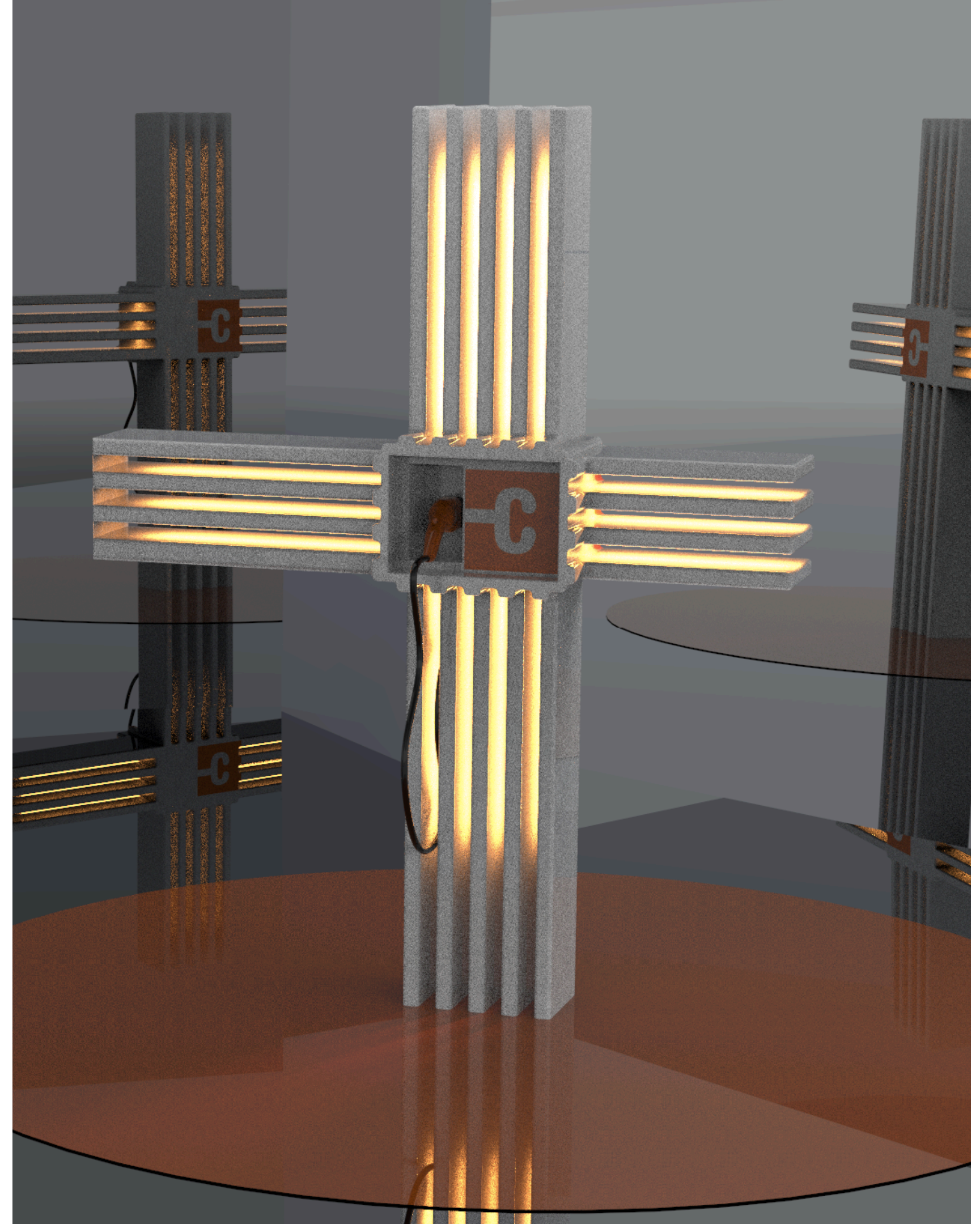
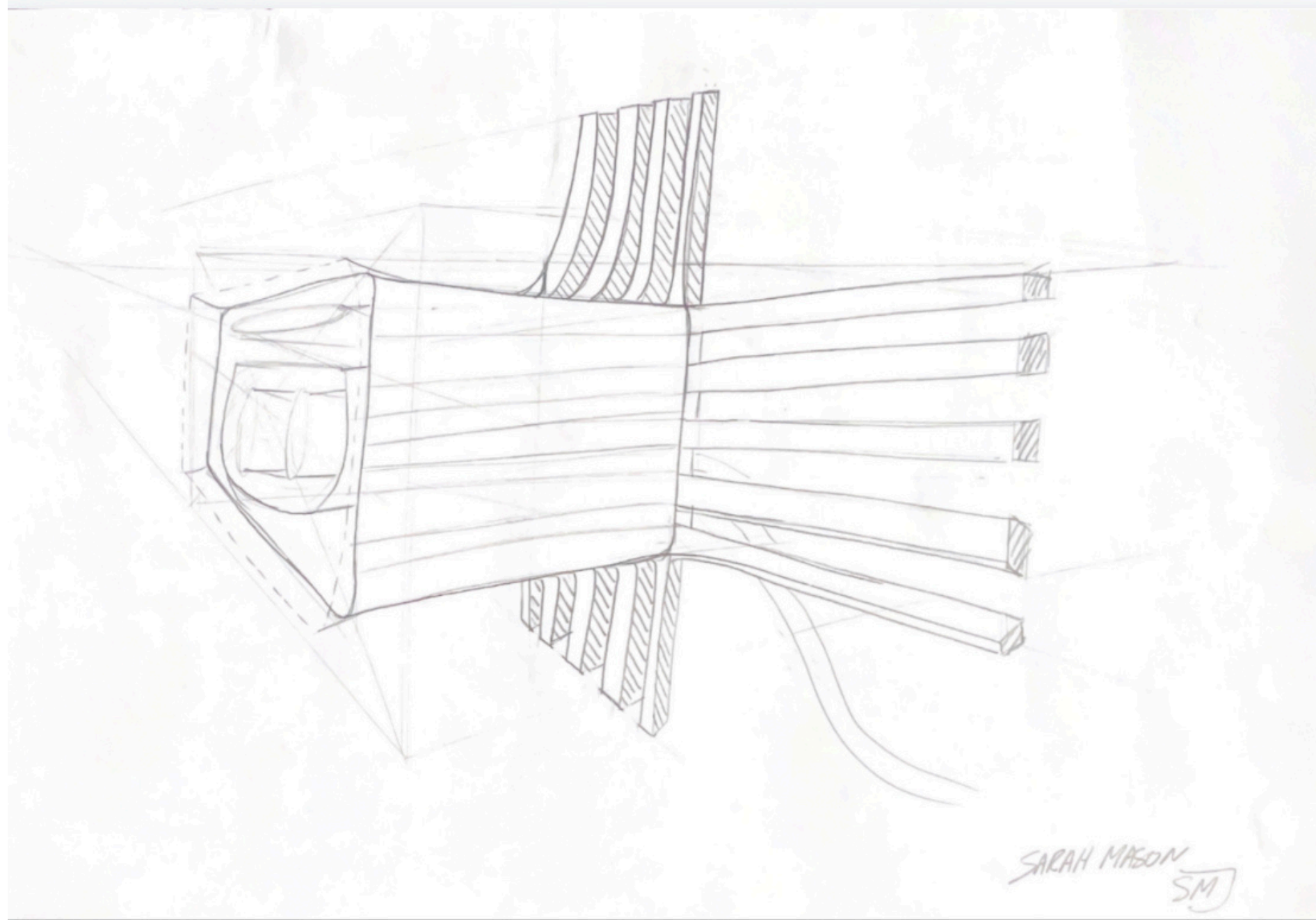

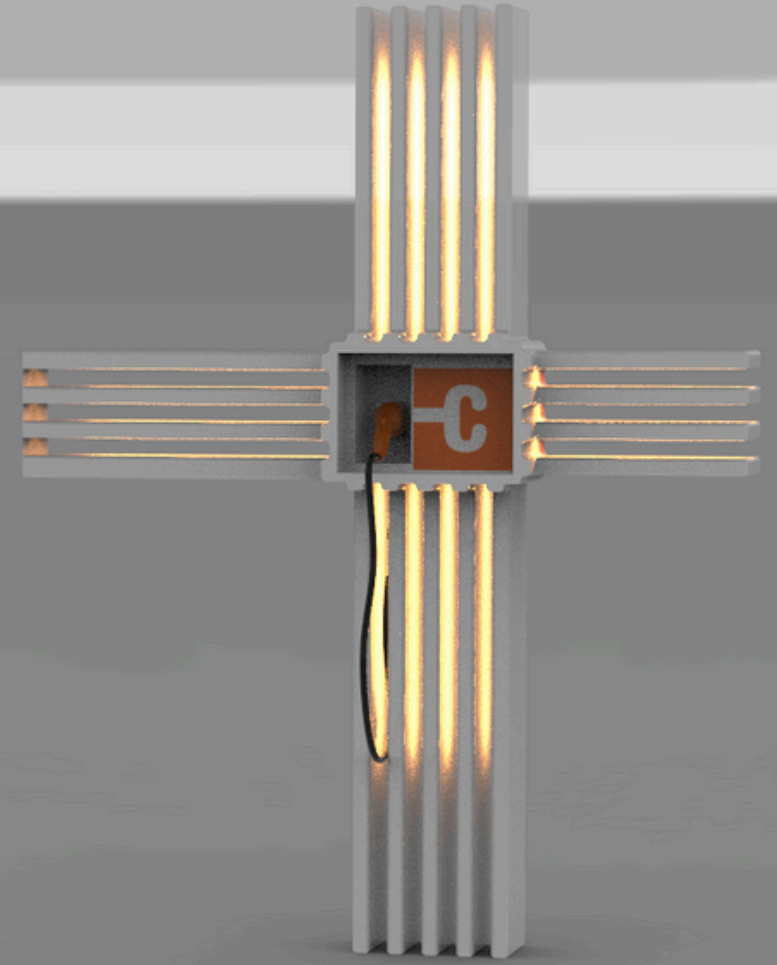
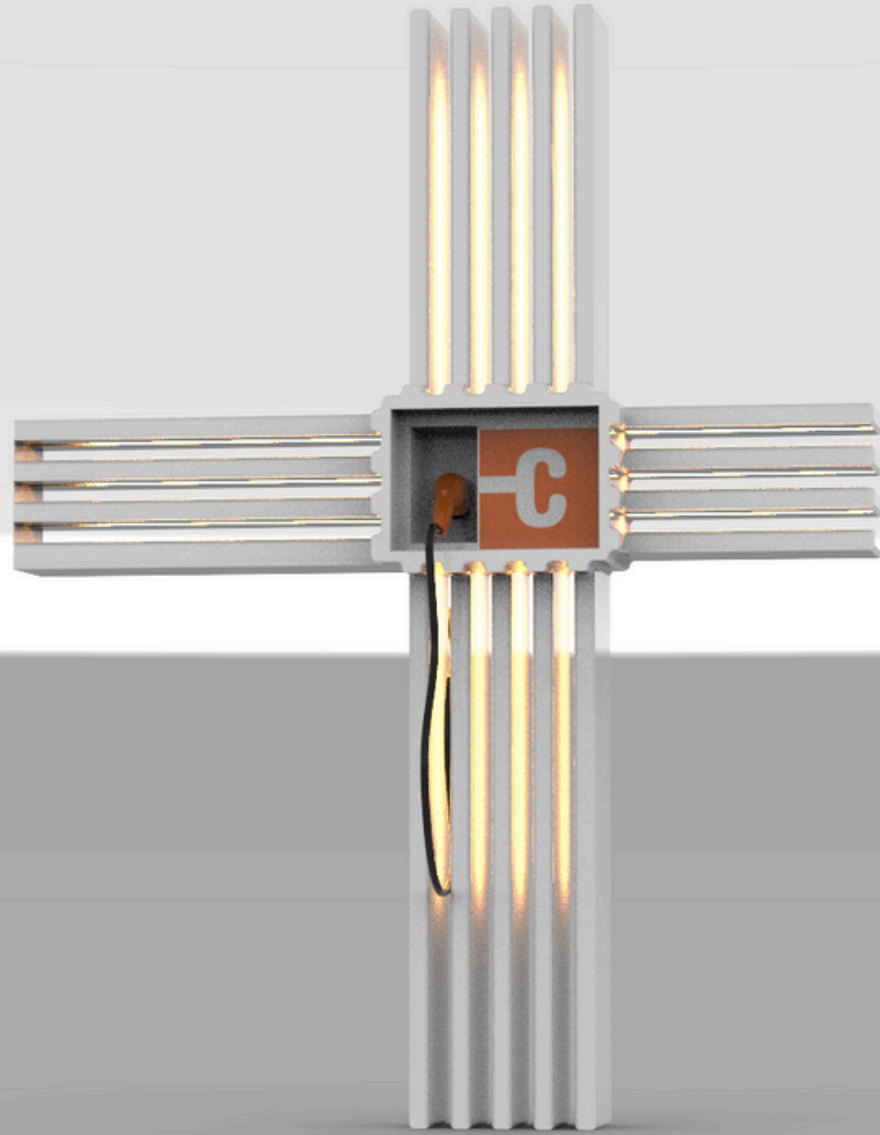
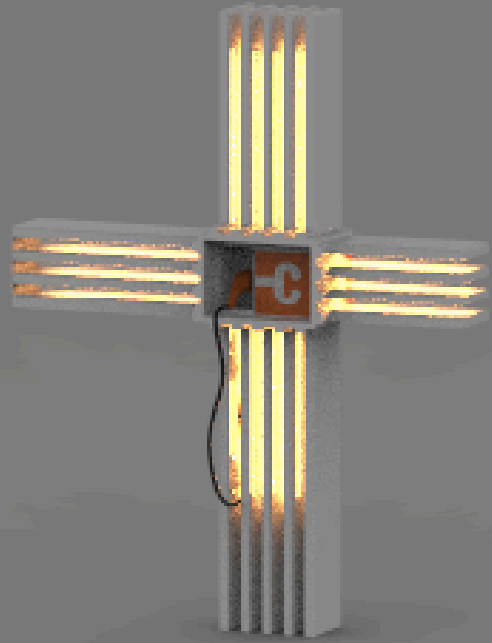



Sonic X Charge Point Flow Chart

